

C1必須盡可能靠近第一腳
C1 must be close to pin1 as possible

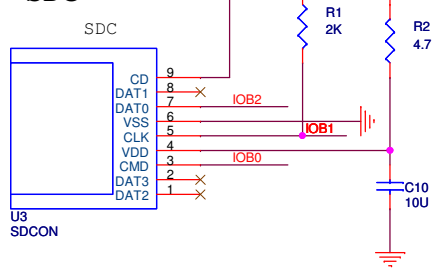

SDC



Chipkingdom Electronics

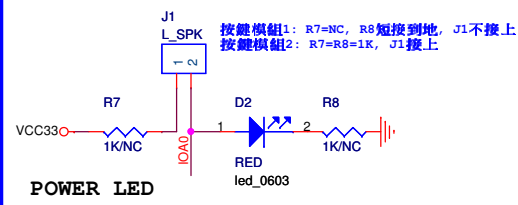
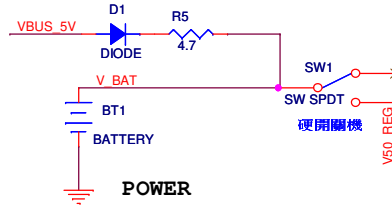

FM RECEIVER

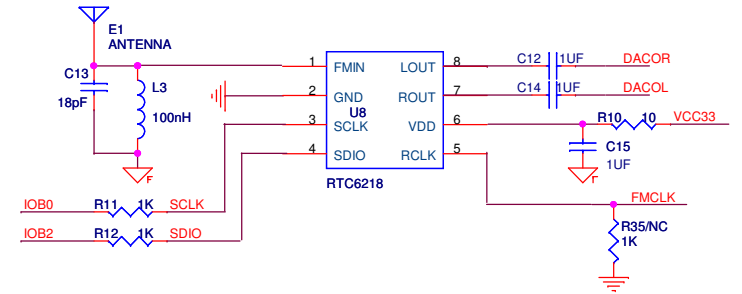

AUDIO

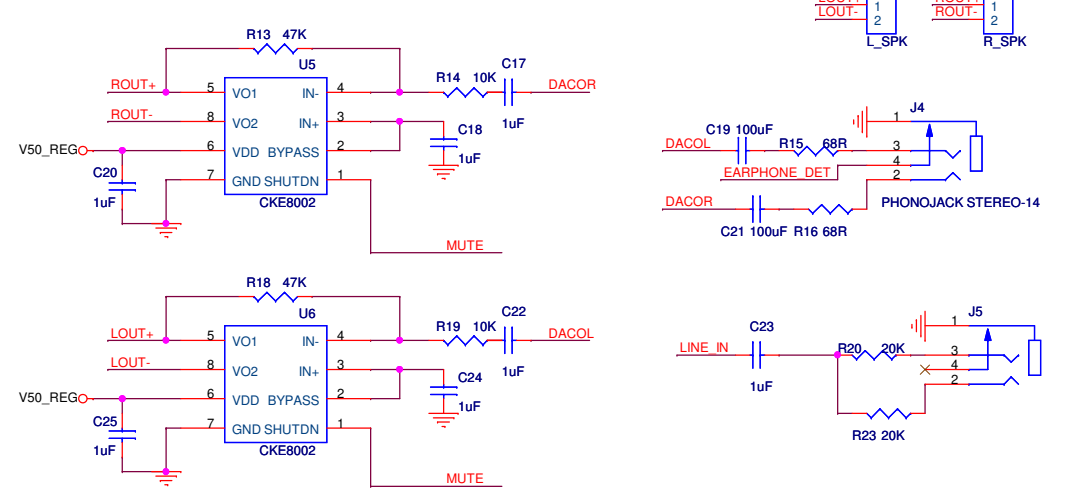

AD KEY

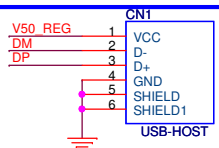
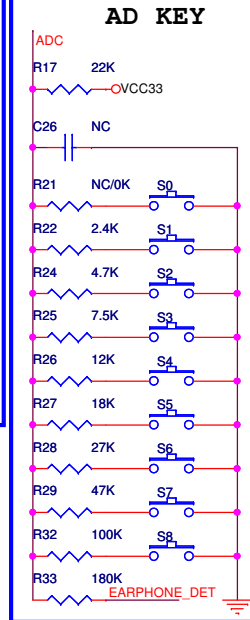

USB Host

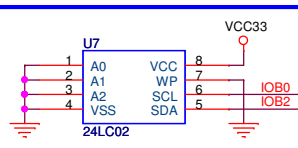

EEPROM

Title		
GPD2856C 16Pin BoomBox		
Size	Document Number	Rev
B	GPD2856C_BoomBox_16Pin.dsn	0.1
Date:	Wednesday, February 26, 2014	Sheet 1 of 1